

- Neck mounted curved blade core (Blades adjustable from face)
- Available in 1, 2, 3, or 4-way air pattern (Factory set)
- Hinged / removable face allows for easy access to damper
- Optional round damper is shipped loose and field mounted
- Model **PV** is all steel construction
- Model **APV** is steel backpan with aluminum face
- Standard finish is white

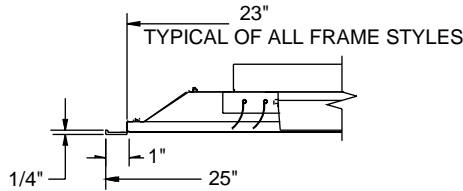

Frame SF (Surface Mount)
*minimum ceiling opening 23-1/4"

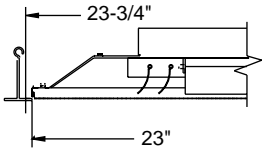

Frame LT (Lay-in T-Bar)

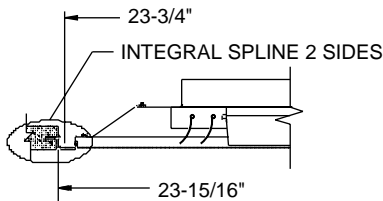

Frame PL (Spline)

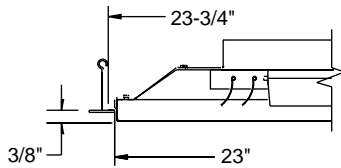

Frame TG (Tegular)

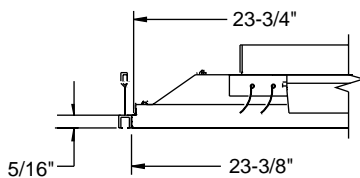

Frame NR (Narrow Regress)

Frame Detail:
24 x 24 Module Size

Air Pattern Options
(specify when ordering)



SEE FRAME DETAIL FOR
TYPICAL OVERALL
DIMENSIONS

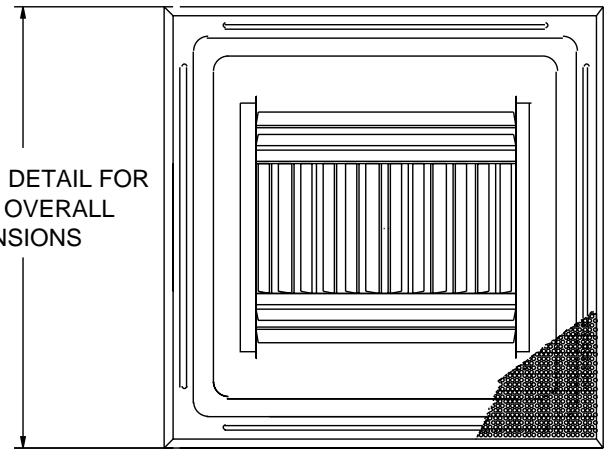

PV

APV

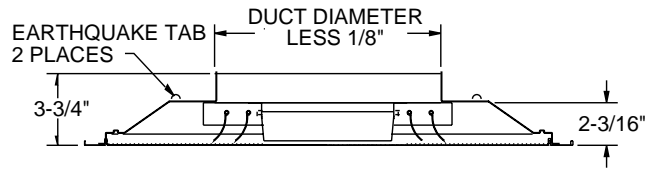

Side View Detail, SF Frame

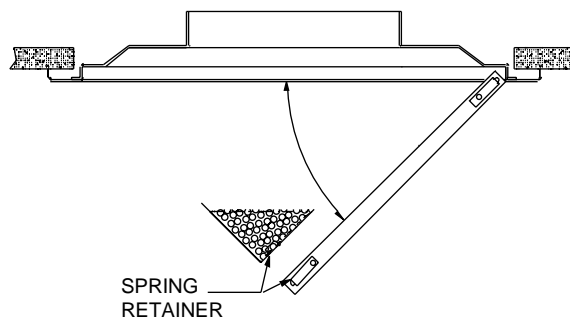

Face Hinge Detail

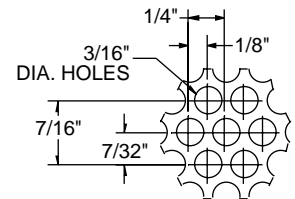

Perforated Pattern Detail
(51% free area)

Dimensions are in inches. Product information subject to change without notice.

PROJECT:	SUBMITTED BY:	DATE: 7/2/01	SD - 1773
ARCHITECT:		PV, APV Round Neck Perforated Supply with Curved Blade Core 24 x 24 Module Only	
ENGINEER:			
CONTRACTOR:			
LOCATION:			