

Job Name/Location:

Tag #:

Date:

For: File Resubmit

PO No.:

Approval Other

Architect:

GC:

Engr:

Mech:

Rep:

(Company)

(Project Manager)



LS181HSV3
 High Efficiency Single Zone Inverter
 Outdoor Unit (ODU) - LSU181HSV3 Indoor Unit (IDU) - LSN181HSV3



Performance:

Cooling:

Capacity (Btu/h)	18,200
SEER	20.5
EER	12.6

SEER - Seasonal Energy Efficiency Ratio EER - Energy Efficiency Ratio

Heating:

Capacity (Btu/h)	22,000
HSPF	9.7

HSPF - Heating Seasonal Performance Factor

Cooling Nominal Test Conditions: Indoor: 80°F DB/67°F WB Outdoor: 95°F DB/75°F WB
 Heating Nominal Test Conditions: Indoor: 70°F DB/60°F WB Outdoor: 47°F DB/43°F WB

Electrical:

Power Supply (V/Hz/Ø)	208-230/60/1
-----------------------	--------------

Outdoor Unit:

MOP (A)	25
MCA (A)	19
Cooling Rated Amps (A)	15.4
Heating Rated Amps (A)	15.4
Compressor (A)	14.6
Fan Motor (A)	0.25

MOP - Maximum Overcurrent Protection MCA - Minimum Circuit Ampacity

Indoor Unit:

Total Power Input:

Cooling Power Input (kW)	1.45
Heating Power Input (kW)	1.76

Piping:

Liquid Line (in, OD)	3/8
Vapor Line (in, OD)	5/8
Additional Refrigerant (oz/ft)	0.38
Max Pipe Length (ft) ²	98.4
Piping Length (no add'l refrigerant, ft)	24.6
Max Elevation (ft)	49.2

Controls Features:

- 24-Hour on/off timer
- Chaos wind
- Jet cool/Jet heat
- 4-Way auto swing
- Condensate Sensor Connection
- 3M HAF Filter
- Auto changeover
- Energy saving
- Self-cleaning indoor coil
- Auto restart
- Inverter (variable speed compressor)
- Sleep mode
- Built-in low ambient standard, down to 14°F (cooling mode)
- Cooling only function

Optional Accessories (sold separately)

- LG Programmable Thermostat - PREMTB100
- Low Ambient Wind Baffle (Cooling operation to 0°F) - ZLABGP02A
- PI485 - PMNFP14A0

For continual product development, LG reserves the right to change specifications without notice.

© LG Electronics U.S.A., Inc., Englewood Cliffs, NJ. All rights reserved. "LG Life's Good" is a registered trademark of LG Corp. /www.lghvac.com

Operating Range:

Outdoor Unit:

Cooling (°F DB)	14-118
Heating (°F WB)	-4-75

Indoor Unit:

Cooling (°F WB)	64-90
Heating (°F DB)	60-86

Unit Data:

Refrigerant Type	R410A
Refrigerant Control	EEV
Refrigerant Charge (lbs)	3.97
ODU Sound Pressure (±3 dB(A)) ³	53
IDU Sound Pressure (H/M/L) (±3 dB(A)) ³	45/40/35
ODU Net Unit Weight (lbs)	123
ODU Shipping Weight (lbs)	131
IDU Net Unit Weight (lbs)	32
IDU Shipping Weight (lbs)	41
Heat Exchanger Coating	GoldFin™

Fan:

ODU Type	Propeller
IDU Type	Cross Flow
Fan Speeds (Fan/Cooling/Heating)	6/6/6
Quantity (ODU + IDU)	1 + 1
Motor/Drive	Brushless Digitally Controlled/Direct
ODU Max Air Flow Rate (CFM)	2,119
IDU Air Flow H/M/L (CFM)	622/509/399
Dehumidification (pts/hr)	5.5

Notes:

1. Acceptable operating voltage: 187V-253V.
2. Piping lengths are equivalent.
3. Sound Pressure levels are tested in an anechoic chamber under ISO Standard 1996.
4. All communication/power cable to be minimum 18 AWG, 4-conductor, stranded, shielded and must comply with applicable local and national code.
5. See Engineering Manual for sensible and latent capacities.
6. Power wiring cable size must comply with the applicable local and national code.
7. The indoor unit comes with a dry helium charge.
8. This data is rated 0 ft above sea level, with 24.6 ft of refrigerant line and a 0 ft level difference between outdoor and indoor units.
9. Must follow installation instructions in the applicable LG installation manual.



Outdoor Unit (ODU) - LSU181HSV3
 High Efficiency Single Zone Inverter



Tag #:

Date:

PO No.:

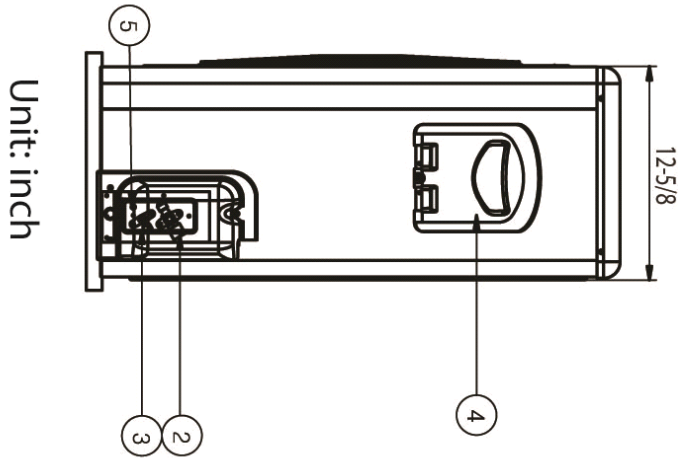
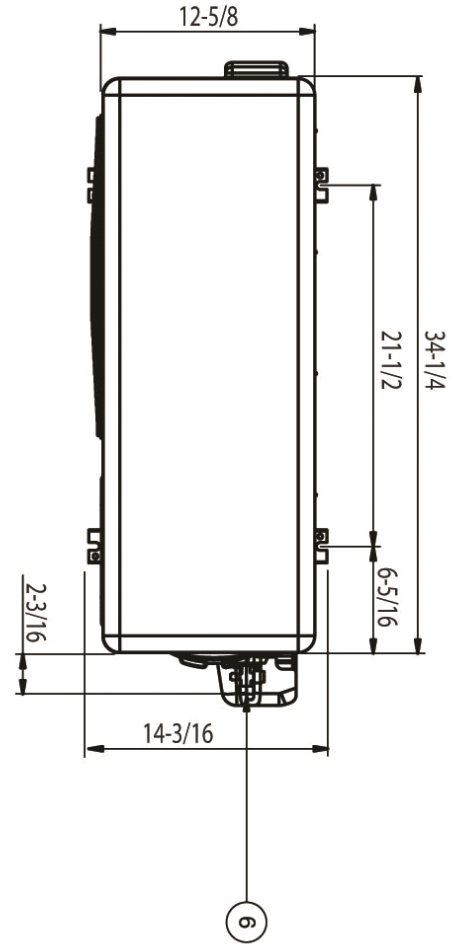
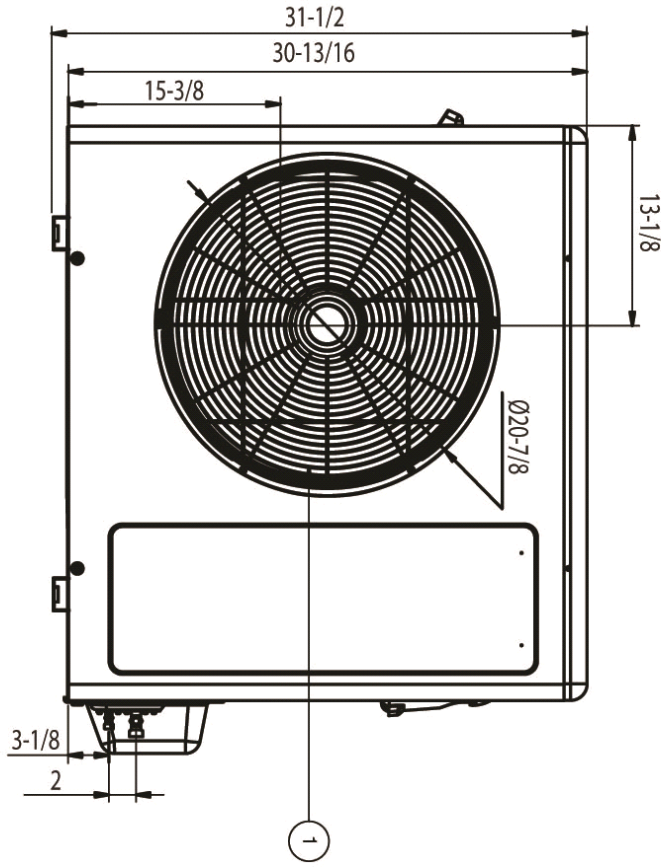

Unit: inch

Item No.	Part Name	Remarks
1	Return Air Grille	
2	Gas pipe connection	
3	Liquid pipe connection	
4	Power & Transmission connection	
5	Earth screw	
6	SVC valve cover	

Indoor Unit (IDU) - LSN181HSV3

High Efficiency Single Zone Inverter



Tag #: _____
 Date: _____
 PO No.: _____

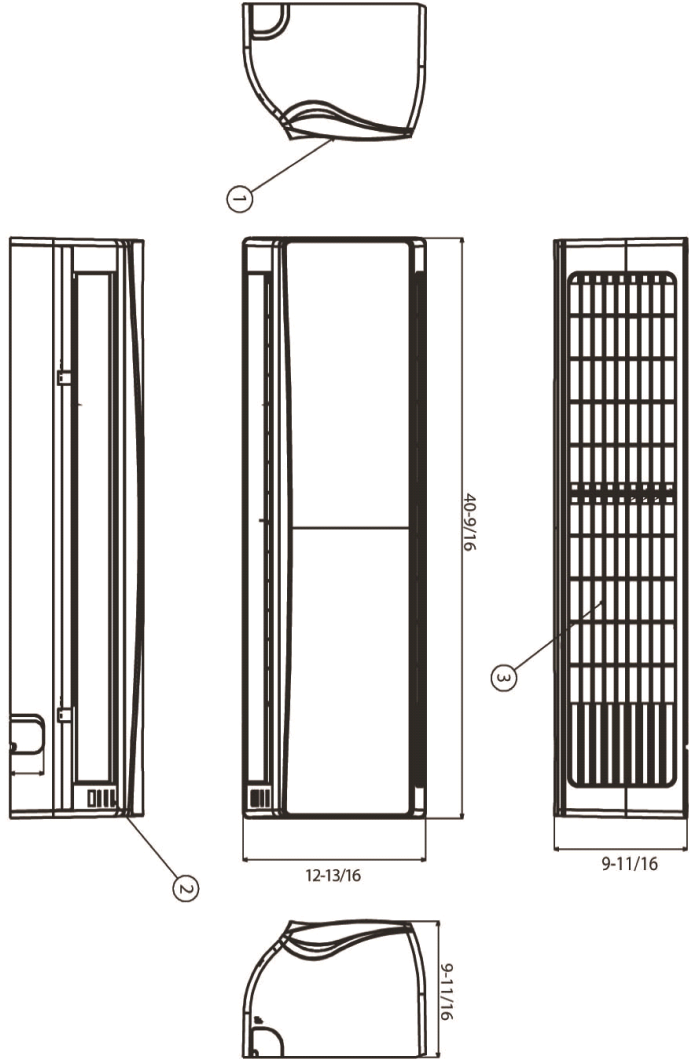
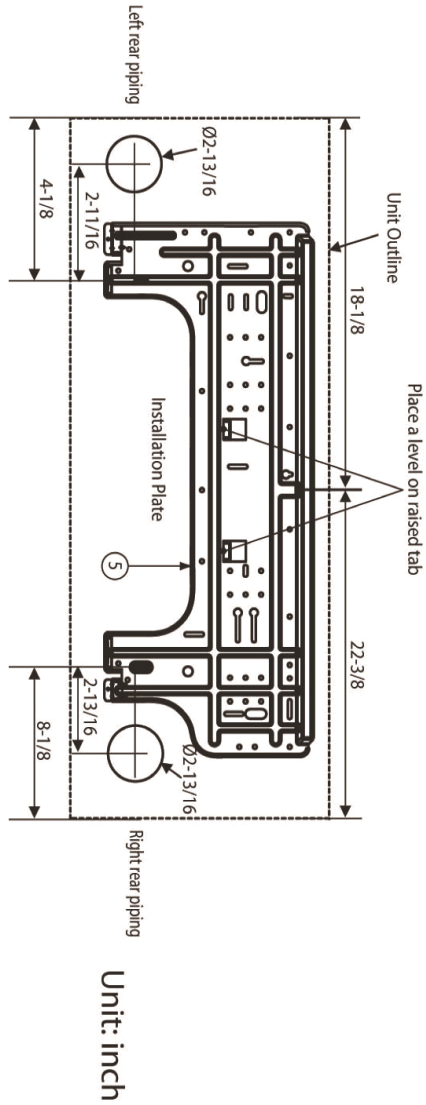

Item No.	Part Name	Remarks
1	Front Panel	
2	Display & Signal Receiver	
3	Return Air Grille	
4	Installation Plate	